

Parts Breakdown

Item 19480

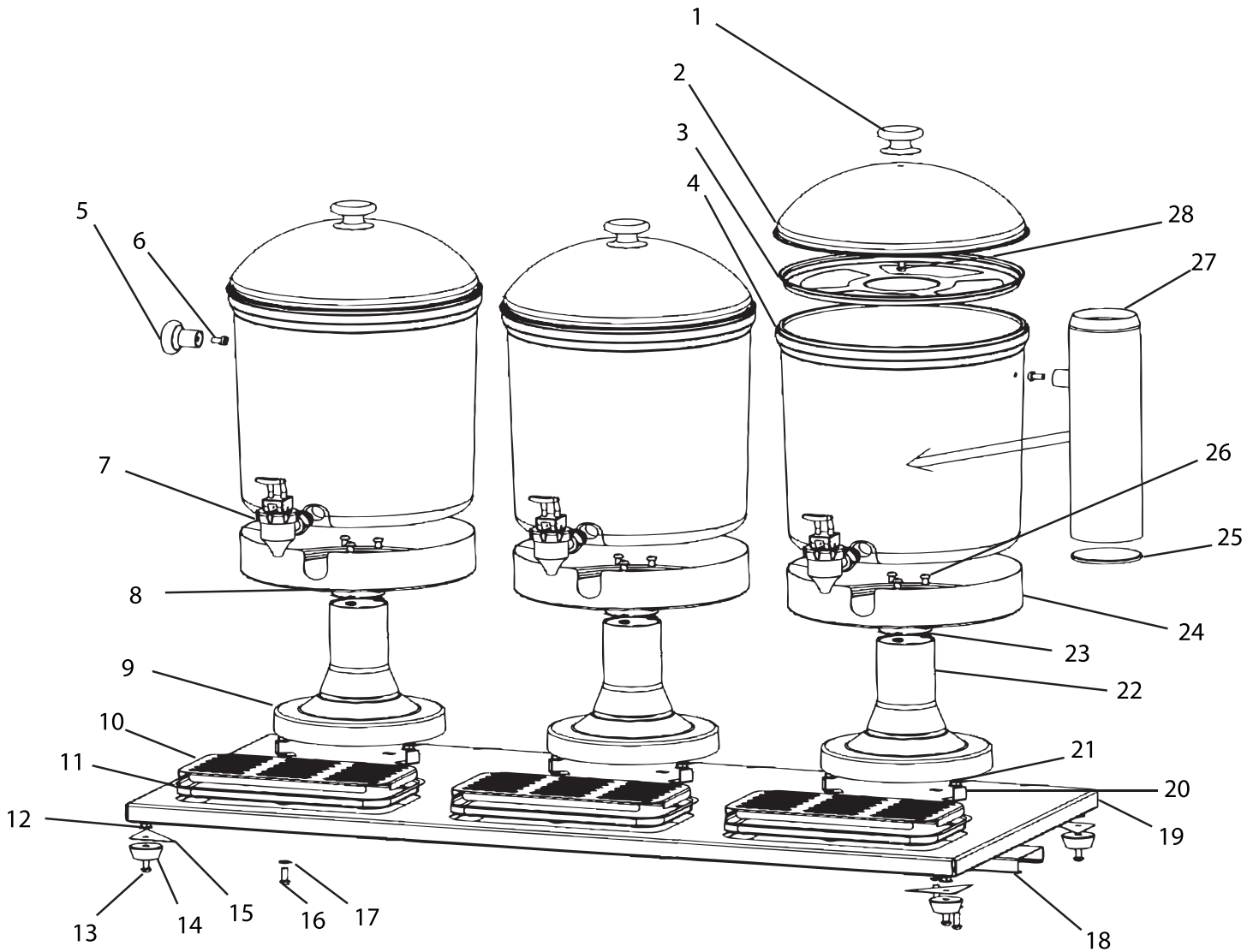

Parts Breakdown

Item 19480

Item No.	Description	Position	Item No.	Description	Position	Item No.	Description	Position
31472	Top Handlebar for 19480	1	77976	Holder Seat Assembly for 19480	9	77974	Flat for 19480	17
31473	Lid for 19480	2	31478	Net Seat for 19480	10	77977	Screw for Holder for 19480	23
31474	Net for 19480	3	31479	Water Seat for 19480	11	77978	Tray for 19480	24
31475	PC Body for 19480	4	77970	F-Screw for 19480	12	31480	Ice Pipe for 19480	25, 27
31476	Handlebar for 19480	5	77971	Nut for 19480	13	77979	Bolt-3 for 19480	26
31477	Small Screw for 19480	6	77972	Feet for 19480	14	77980	Bolt for 19480	28
27956	Tap for 19480	7	63542	Board Assembly for 19480	15 - 21	79581	Handle Seals for 19480	
77969	Small Cover for 19480	8	77973	Bolt-1 for 19480	16			